

Product Specification

Part Name: OEL Display Module

Part ID: UG-2864GMBAF01

Doc No.: SAS1-9008-A

Customer:
Approved by

CONFIDENTIAL

From: Univision Technology Inc.
Approved by

Univision Technology Inc.

8, Kebei RD 2, Science Park, Chu-Nan, Taiwan 350, R.O.C.

Notes:

1. Please contact Univision Technology Inc. before assigning your product based on this module specification
2. The information contained herein is presented merely to indicate the characteristics and performance of our products. No responsibility is assumed by Univision Technology Inc. for any intellectual property claims or other problems that may result from application based on the module described herein.

Revised History

Part Number	Revision	Revision Content	Revised on
UG-2864GMBAF01	A	New	July 2, 2005
CONFIDENTIAL			

CONFIDENTIAL

Notice:

No part of this material may be reproduced or duplicated in any form or by any means without the written permission of Univision Technology Inc. Univision Technology Inc. reserves the right to make changes to this material without notice. Univision Technology Inc. does not assume any liability of any kind arising out of any inaccuracies contained in this material or due to its application or use in any product or circuit and, further, there is no representation that this material is applicable to products requiring high level reliability, such as, medical products. Moreover, no license to any intellectual property rights is granted by implication or otherwise, and there is no representation or warranty that anything made in accordance with this material will be free from any patent or copyright infringement of a third party. This material or portions thereof may contain technology or the subject relating to strategic products under the control of Foreign Exchange and Foreign Trade Law of Taiwan and may require an export license from the Ministry of International Trade and Industry or other approval from another government agency.

© Univision Technology Inc. 2005, All rights reserved.

All other product names mentioned herein are trademarks and/or registered trademarks of their respective companies.

Contents

Revision History	<i>i</i>
Notice	<i>ii</i>
Contents	<i>iii</i>
1. Basic Specifications	<i>1~4</i>
1.1 Display Specifications	1
1.2 Mechanical Specifications	1
1.3 Active Area & Pixel Construction	1
1.4 Mechanical Drawing	2
1.5 Pin Definition	3
1.6 Block Diagram	4
2. Absolute Maximum Ratings	<i>5</i>
2.1 Absolute Maximum Ratings	5
2.2 Regarding the Gradation	5
3. Electrical Characteristics	<i>6~8</i>
3.1 DC Characteristics	6
3.2 AC Characteristics	7
3.3 Optics & Electrical Characteristics	8
3.4 General Electrical Specification	8
4. Functional Specification	<i>9~10</i>
4.1 Commands	9
4.2 Power down and Power up Sequence	9
4.2.1 Power up Sequence	9
4.2.2 Power down Sequence	9
4.3 Reset Circuit	9
4.4 Actual Application Example	10
5. Reliability	<i>11</i>
5.1 Contents of Reliability Tests	11
5.2 Lifetime	11
5.3 Failure Check Standard	11
6. Outgoing Quality Control Specifications	<i>12~16</i>
6.1 Environment Required	12
6.2 Sampling Plan	12
6.3 Criteria & Acceptable Quality Level	12
6.3.1 Cosmetic Check (Display Off) in Non-Active Area	12
6.3.2 Cosmetic Check (Display On) in Active Area	14
6.3.3 Pattern Check (Display On) in Active Area	15
7. Package Specifications	<i>17~18</i>
7.1 Inner Carton Box	17
7.2 Master Carton Box	18

8. Precautions When Using These OEL Display Modules.....	19~21
8.1 Handling Precautions	19
8.2 Storage Precautions.....	20
8.3 Designing Precautions	20
8.4 Precautions when disposing of the OEL display modules.....	20
8.5 Other Precautions.....	20

CONFIDENTIAL

1. Basic Specifications

1.1 Display Specifications

- 1) Display Mode: Passive Matrix
- 2) Display Color: Area Color (Light Blue, Yellow)
- 3) Drive Duty: 1/64 Duty

1.2 Mechanical Specifications

- 1) Outline Drawing: According to the annexed outline drawing number
- 2) Number of Pixels: 128 × 64
- 3) Panel Size: 30.00 × 20.16 × 1.80 (mm)
- 4) Active Area: 23.02 × 11.86 (mm)
- 5) Pixel Pitch: 0.18 × 0.18 (mm)
- 6) Pixel Size: 0.16 × 0.16 (mm)
- 7) Weight: 2.0 (g)

1.3 Active Area & Pixel Construction

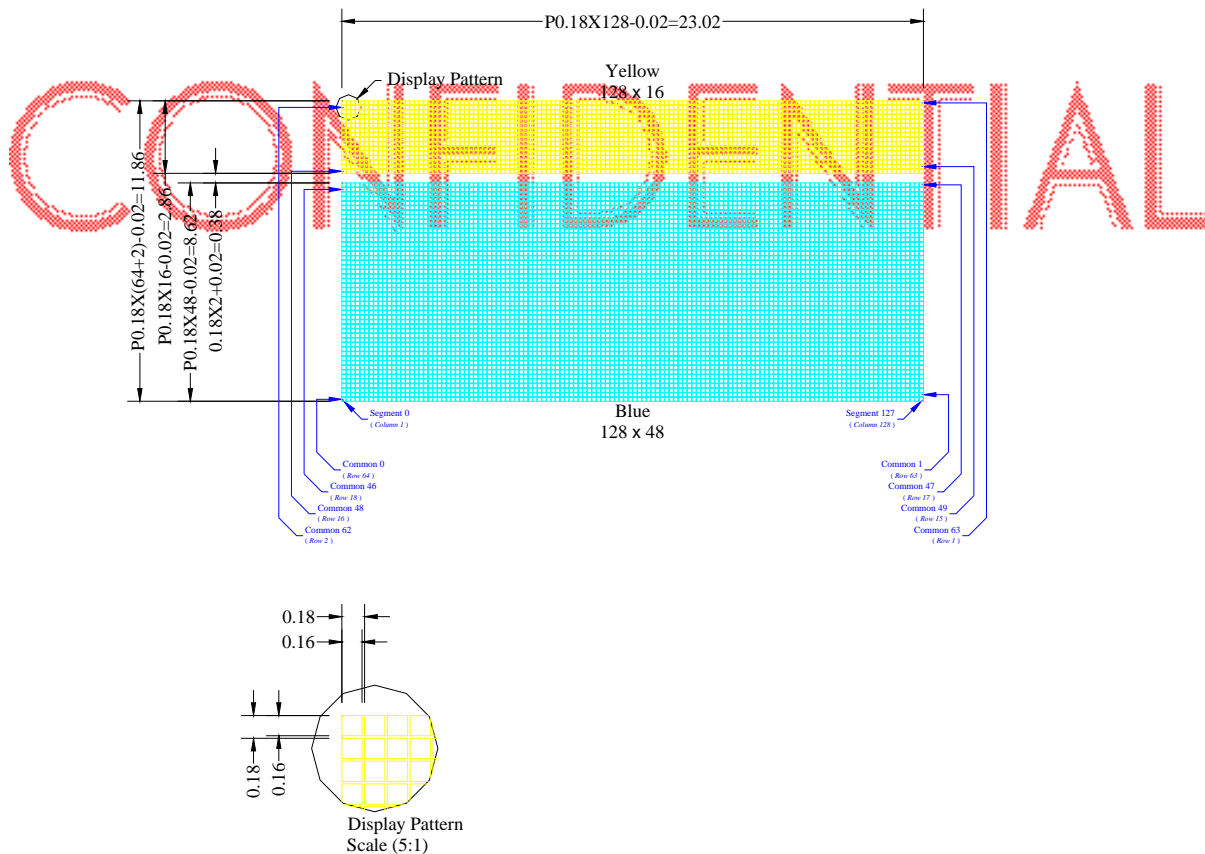

1.4 Mechanical Drawing

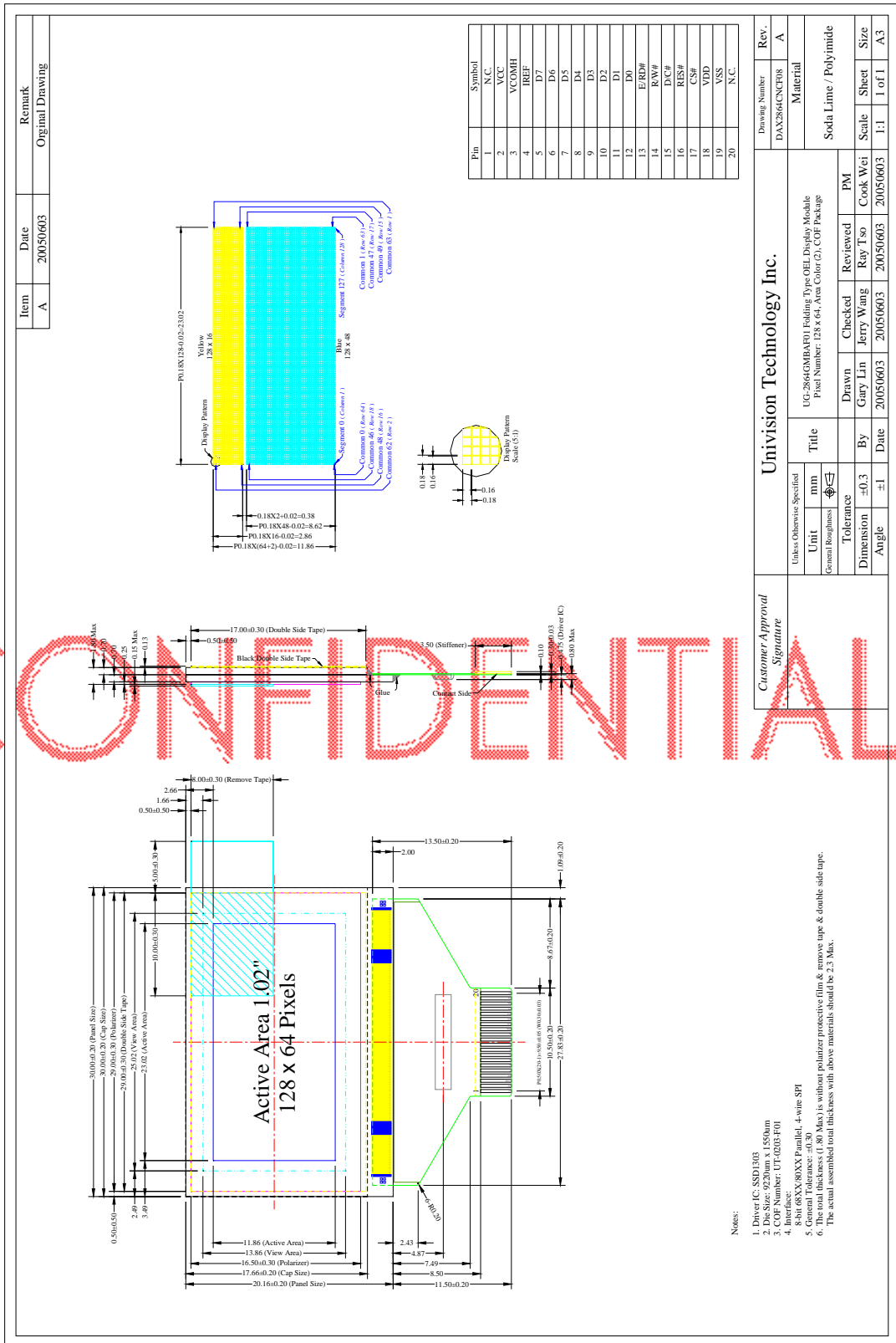

CONFIDENTIAL

The drawing contained herein is the exclusive property of Univision. It is not allowed to copy, reproduce or disclose in any format without permission of Univision.

1.5 Pin Definition

Pin Number	Symbol	I/O	Function
18	VDD	I	Power Supply for Logic Circuit This is a voltage supply pin. It must be connected to external source.
19	VSS	I	Ground of OEL System This is a ground pin. It also acts as a reference for the logic pins, the OEL driving voltages, and the analog circuits. It must be connected to external ground.
2	VCC	I/O	Power Supply for OEL Panel This is the most positive voltage supply pin of the chip. It can be supplied externally or generated internally by using internal DC/DC voltage converter.
4	IREF	I	Current Reference for Brightness Adjustment This pin is segment current reference pin. A resistor should be connected between this pin and VSS. Set the current at 10uA.
3	VCOMH	I/O	Voltage Output High Level for COM Signal This pin is the input pin for the voltage output high level for COM signals. A capacitor should be connected between this pin and VSS.
16	RES#	I	Power Reset for Controller and Driver This pin is reset signal input. When the pin is low, initialization of the chip is executed.
17	CS#	I	Chip Select This pin is the chip select input. The chip is enabled for MCU communication only when CS# is pulled low.
13	E/RD#	I	Read Select This pin is MCU interface input. It receives the Read (RD#) signal. Data read operation is initiated when this pin is pulled low and CS# is pulled low.
14	R/W#	I	Write Select This pin is MCU interface input. It will be the Write (WR#) input. Data write operation is initiated when this pin is pulled low and the CS# is pulled low.
15	D/C#	I	Data/Command Control This pin is Data/Command control pin. When the pin is pulled high, the input at D7~D0 is treated as display data. When the pin is pulled low, the input at D7~D0 will be transferred to the command register. For detail relationship to MCU interface signals, please refer to the Timing Characteristics Diagrams.
5~12	D7~D0	I/O	Host Data Input/Output Bus These pins are 8-bit bi-directional data bus to be connected to the microprocessor's data bus.
1, 20	N.C.	-	Reserved Pin (Supporting Pin) The supporting pins can reduce the influences from stresses on the function pins.

CONFIDENTIAL

1.6 Block Diagram

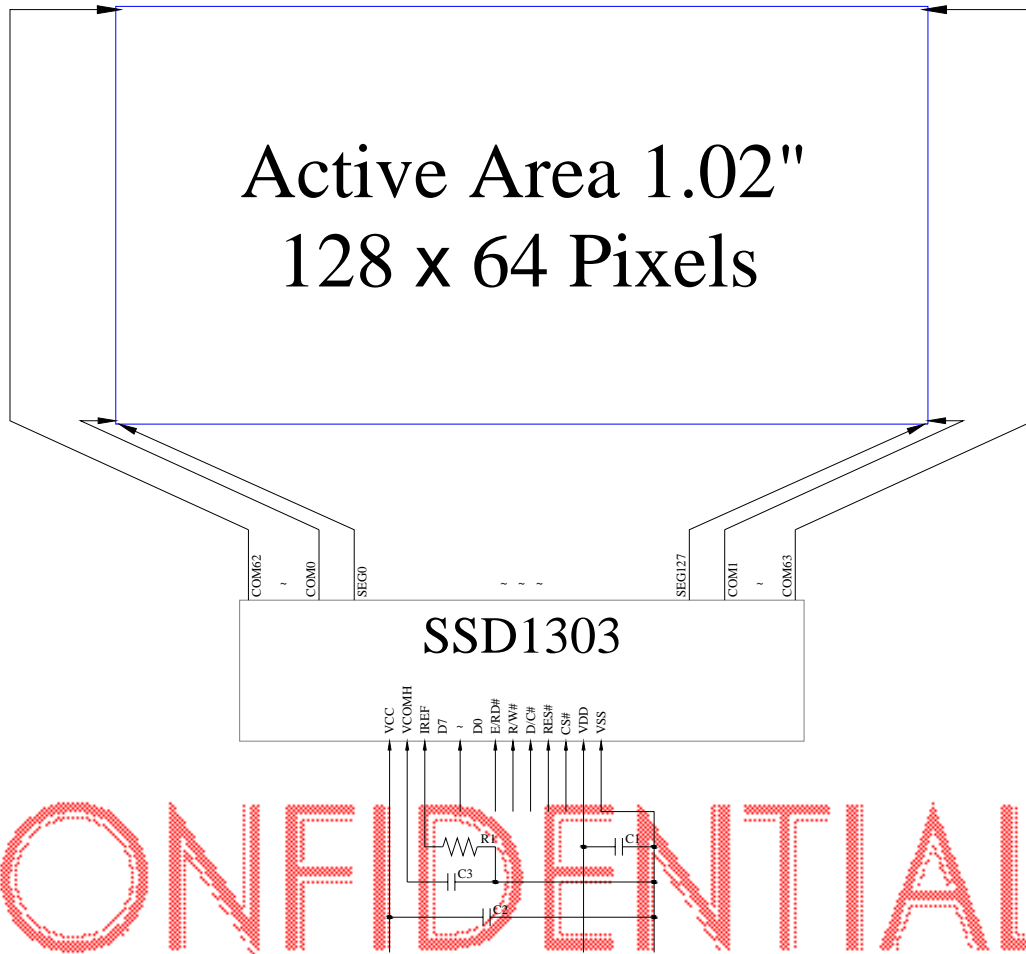

CONFIDENTIAL

Pins connected to MCU interface: D7~D0, E/RD#, R/W#, D/C#, RES#, and CS#

C1, C3: 4.7μF

C2: 10μF

R1: 910kΩ, $R1 = (\text{Voltage at IREF} - \text{BGGND}) / \text{IREF}$

2. Absolute Maximum Ratings

2.1 Absolute Maximum Ratings

Parameter	Symbol	Min	Max	Unit	Notes
Supply Voltage	V _{DD}	-0.3	4	V	1, 2
Driver Supply Voltage	V _{CC}	0	15	V	1, 2
Operating Temperature	T _{OP}	-20	70	°C	-
Storage Temperature	T _{STG}	-30	80	°C	-

Note 1: All the above voltages are on the basis of “GND = 0V”.

Note 2: When this module is used beyond the above absolute maximum ratings, permanent breakage of the module may occur. Also, for normal operations, it is desirable to use this module under the conditions according to Section 3. “Electrical Characteristics”. If this module is used beyond these conditions, malfunctioning of the module can occur and the reliability of the module may deteriorate.

2.2 Regarding the Gradation

Although this module possesses the gradation function, respective gradation levels will vary depending on the production conditions etc. Also, the temperature range where the gradation function can be guaranteed will be -10°C~60°C.

CONFIDENTIAL

3. *Electrical Characteristics*

3.1 DC Characteristics

Characteristics	Symbol	Conditions	Min	Typ	Max	Unit
Supply Voltage	V _{DD}		2.6	2.8	3.5	V
Driver Supply Voltage	V _{CC}		-	9	-	V
High Level Input	V _{IH}	I _{out} = 100μA, 3.3MHz	0.8×V _{DD}	-	V _{DD}	V
Low Level Input	V _{IL}	I _{out} = 100μA, 3.3MHz	0	-	0.2×V _{DD}	V
High Level Output	V _{OH}	I _{out} = 100μA, 3.3MHz	0.9×V _{DD}	-	V _{DD}	V
Low Level Output	V _{OL}	I _{out} = 100μA, 3.3MHz	0	-	0.1×V _{DD}	V

CONFIDENTIAL

3.2 AC Characteristics

Symbol	Description	Min	Max	Unit
t_{cycle}	Clock Cycle Time	300	-	ns
t_{AS}	Address Setup Time	0	-	ns
t_{AH}	Address Hold Time	0	-	ns
t_{DSW}	Write Data Setup Time	40	-	ns
t_{DHW}	Write Data Hold Time	15	-	ns
t_{DHR}	Read Data Hold Time	20	-	ns
t_{OH}	Output Disable Time	-	70	ns
t_{ACC}	Access Time	-	140	ns
PW_{CSL}	Chip Select Low Pulse Width (Read)	120	-	ns
	Chip Select Low Pulse Width (Write)	60	-	ns
PW_{CSH}	Chip Select High Pulse Width (Read)	60	-	ns
	Chip Select High Pulse Width (Write)	60	-	ns
t_{R}	Rise Time	-	15	ns
t_{F}	Fall Time	-	15	ns

* All the timings should be based on 30% and 70% of $V_{\text{DD}}-\text{GND}$.

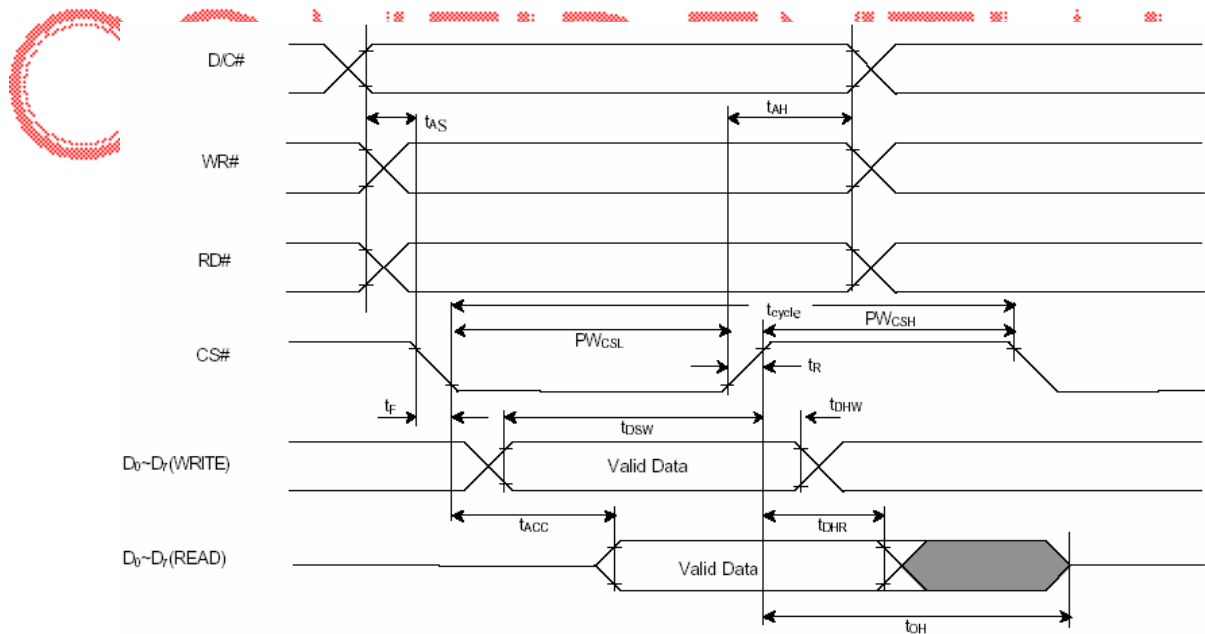

3.3 Optics & Electrical Characteristics

Characteristics	Symbol	Conditions	Min	Typ	Max	Unit
Brightness	L_{br}	With Polarizer	35	60	-	cd/m ²
C.I.E. (Blue)	(x)	Without Polarizer	0.12	0.16	0.20	
	(y)		0.22	0.26	0.30	
C.I.E. (Yellow)	(x)	Without Polarizer	0.43	0.47	0.51	
	(y)		0.46	0.50	0.54	
Dark Room Contrast	CR		-	>1:100	-	
View Angle			>160	-	-	degree

Note 3: Optical measurement taken at 1/64 duty, 100Hz Frame Rate, 0xFF Contrast Setting.

3.4 General Electrical Specification

Characteristics	Symbol	Conditions	Min	Typ	Max	Unit
Supply Voltage	V_{DD}		2.6	2.8	3.5	V
Driver Supply Voltage	V_{CC}		8	9	10	V
Operating Current for V_{DD}	I_{DD}	Note 4	-	2.0	4.5	mA
		Note 5	-	2.0	4.5	mA
Operating Current for V_{CC}	I_{CC}	Note 4	-	6.0	10.4	mA
		Note 5	-	9.8	14.7	mA

Note 4: $V_{DD} = 2.8V$, $V_{CC} = 9V$, Frame Rate = 100Hz, Contrast Setting = 0xFF, 50% Display Area Turn on.

Note 5: $V_{DD} = 2.8V$, $V_{CC} = 9V$, Frame Rate = 100Hz, Contrast Setting = 0xFF, 100% Display Area Turn on.

4. Functional Specification

4.1. Commands

Refer to the Technical Manual for the SSD1303

4.2 Power down and Power up Sequence

To protect OEL panel and extend the panel life time, the driver IC power up/down routine should include a delay period between high voltage and low voltage power sources during turn on/off. It gives the OEL panel enough time to complete the action of charge and discharge before/after the operation.

4.2.1 Power up Sequence:

1. Power up V_{DD}
2. Send Display off command
3. Clear Screen
4. Power up V_{CC}
5. Delay 100ms
(when V_{DD} is stable)
6. Send Display on command

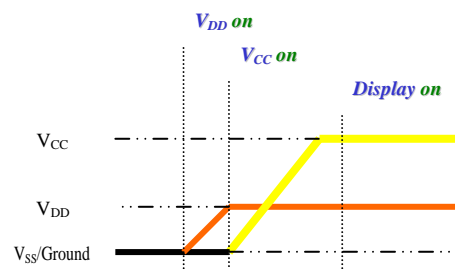

4.2.2 Power down Sequence:

1. Send Display off command
2. Power down V_{CC}
3. Delay 100ms
(when V_{CC} is reach 0 and panel is completely discharges)
4. Power down V_{DD}

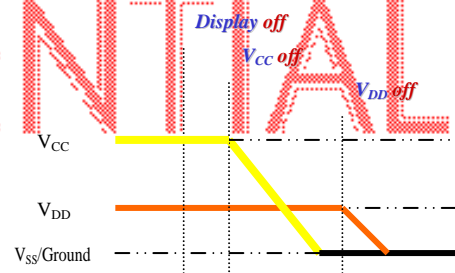

4.3 Reset Circuit

When RES# input is low, the chip is initialized with the following status:

1. Display is OFF
2. 132×64 Display Mode
3. Normal segment and display data column and row address mapping (SEG0 mapped to column address 00H and COM0 mapped to row address 00H)
4. Shift register data clear in serial interface
5. Display start line is set at display RAM address 0
6. Column address counter is set at 0
7. Normal scan direction of the COM outputs
8. Contrast control register is set at 80H
9. Internal booster is selected

4.4 Actual Application Example

Command usage and explanation of an actual example

<Initialization Setting>

Set Display Clock Divide Ratio / Oscillator Frequency
(11010101 with XXXXXXXX)

Set Display Offset
(11010011 with **XXXXXX)
* XXXXXX = 64 - Dummy Lines from Common 0

Set Multiplex Ratio
(10101000 with **XXXXXX)

Set DC/DC On/Off
(10101101 with 1000101X)
10001010 => 0x8A (Off)
Set Area Color Mode & Low Power Display Mode
(11011000 with 00XX0X0X)
00000101 => 0x05 (Mono & Low Power Save Mode)

Set Display Start Line
(01XXXXXX)

Set Segment Re-map
(1010000X)

Set COM Output Scan Direction
(1100X***)

Set COM Pins Hardware Configuration
(11011010 with 000X0010)
00010010 => 0x12 (Alternative Mode)

Set Contrast Control Register
(10000001 with XXXXXXXX)

Set Entire Display On/Off (1010010X)
10100100 => 0xA4 (Normal)

Set Normal/Inverse Display (1010011X)
10100110 => 0xA6 (Normal)

Set Display On/Off (1010111X)
10101111 => 0xAF (Turns On)

<Display Boundary Setting>

Set Page Address (1011XXXX)
10110000 => 0xB0

Set Lower Column Address
(0000XXXX)

Set Higher Column Address
(0001XXXX)

If the noise is accidentally occurred at the displaying window during the operation, please reset the display in order to recover the display function.

5. Reliability

5.1 Contents of Reliability Tests

Item	Conditions	Criteria
High Temperature Operation	70°C, 240 hrs	The brightness should be greater than 50% of the initial brightness.
Low Temperature Operation	-20°C, 240 hrs	
High Temperature Storage	80°C, 240 hrs	
Low Temperature Storage	-30°C, 240 hrs	
High Temperature/Humidity Storage	60°C, 90% RH, 240 hrs	
Thermal Shock	-30°C ⇔ 80°C, 10 cycles 30 mins dwell	The operational functions work.

- * The samples used for the above tests do not include polarizer.
- * No moisture condensation is observed during tests.

5.2 Lifetime

End of lifetime is specified as 50% of initial brightness.

An average operating lifetime of more than 10,000 hrs at room temperature is approached by 240 hrs @ 70°C operating.

5.3 Failure Check Standard

After the completion of the described reliability test, the samples were left at room temperature for 2 hrs prior to conducting the failure test at 23±5°C; 55±15% RH.

CONFIDENTIAL

6. Outgoing Quality Control Specifications

6.1 Environment Required

Customer's test & measurement are required to be conducted under the following conditions:

Temperature:	23 ± 5°C
Humidity:	55 ± 15 %RH
Fluorescent Lamp:	30W
Distance between the Panel & Lamp:	≥ 50 cm
Distance between the Panel & Eyes of the Inspector:	≥ 30 cm
Finger glove (or finger cover) must be worn by the inspector.	
Inspection table or jig must be anti-electrostatic.	

6.2 Sampling Plan

Level II, Normal Inspection, Single Sampling, MIL-STD-105E



6.3 Criteria & Acceptable Quality Level

Partition	AQL	Definition
Major	0.65	Defects in Pattern Check (Display On)
Minor	1.0	Defects in Cosmetic Check (Display Off)

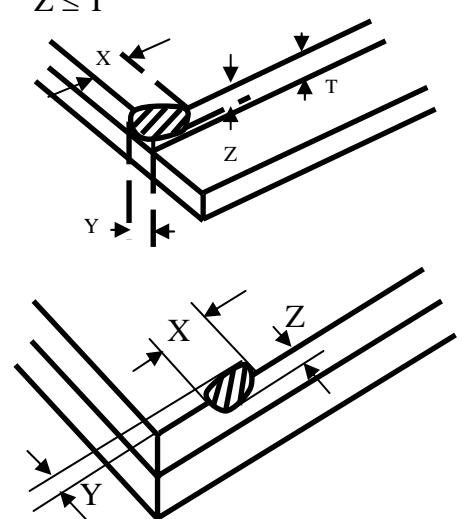
6.3.1 Cosmetic Check (Display Off) in Non-Active Area

Check Item	Classification	Criteria
Panel General Chipping	Minor	<p> $X > 6 \text{ mm}$ (Along with Edge) $Y > 1 \text{ mm}$ (Perpendicular to edge) $Z \leq T$ </p> 

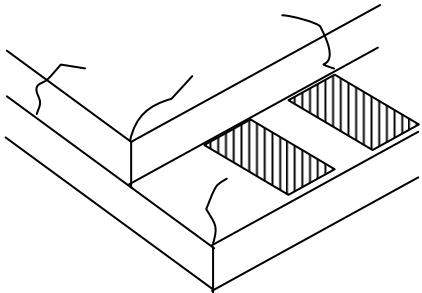
6.3.1 Cosmetic Check (Display Off) in Non-Active Area (Continued)

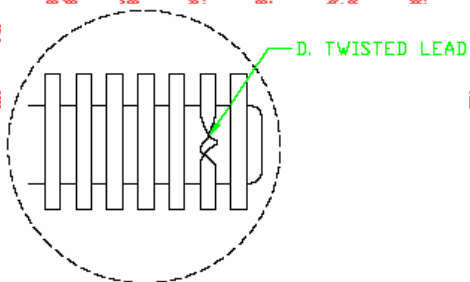
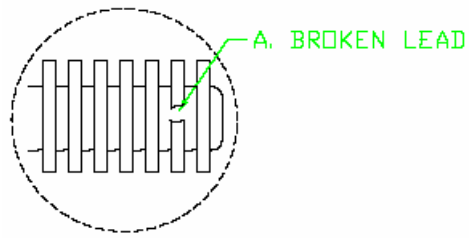
Check Item	Classification	Criteria
Panel Crack	Minor	Any crack is not allowable. 
Copper Exposed (Even Pin or Film)	Minor	Not Allowable by Naked Eye Inspection
Film or Trace Damage	Minor	
Terminal Lead Twist	Minor	Not Allowable 
Terminal Lead Broken	Minor	Not Allowable 
Terminal Lead Prober Mark	Acceptable	Ok

CONFIDENTIAL

6.3.1 Cosmetic Check (Display Off) in Non-Active Area (Continued)

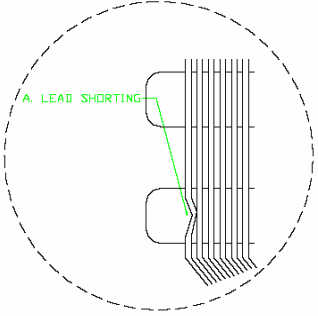
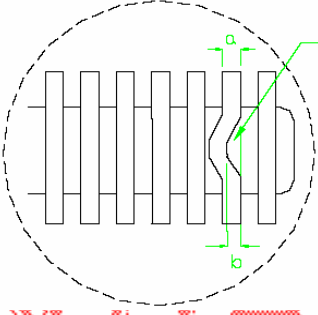
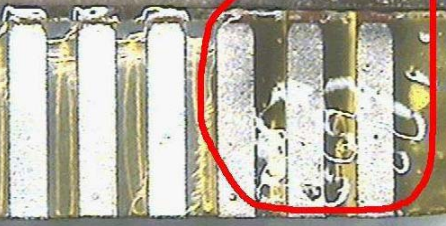
Check Item	Classification	Criteria
Terminal Lead Bent (Not Twist or Broken)	Minor	NG if any bent lead cause lead shorting. 
	Minor	NG for horizontally bent lead more than 50% of its width. 
Glue or Contamination on Pin (Couldn't Be Removed by Alcohol)	Minor	
Ink Marking on Back Side of panel (Exclude on Film)	Acceptable	Ignore for Any

CONFIDENTIAL

6.3.2 Cosmetic Check (Display On) in Active Area

Don't tear off the protective film for only visual check purpose. Otherwise any particle or contamination of air could penetrate & attach onto the surface of polarizer in great probability. It is recommended to execute in clear room environment (class 10k) if actual in necessary.

Check Item	Classification	Criteria
Any Dirt & Scratch on Polarizer's Protective Film	Acceptable	Ignore for not Affect the Polarizer
Scratches, Fiber, Line-Shape Defect ** (On Polarizer)	Minor	$W \leq 0.05$ Ignore $W \leq 0.1, L \leq 2$ $n \leq 3$ $2 < L$ $n = 0$

6.3.2 Cosmetic Check (Display On) in Active Area (Continued)

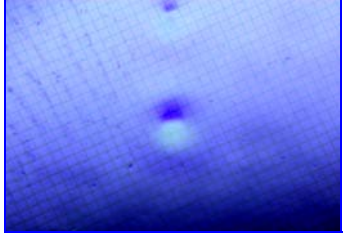
Check Item	Classification	Criteria
Dirt, Black Spot, Foreign Material, ** (On Polarizer)	Minor	$\Phi \leq 0.1$ Ignore $0.1 < \Phi \leq 0.2$ $n \leq 3$ $0.2 < \Phi \leq 0.25$ $n \leq 1$ $0.25 < \Phi$ $n = 0$
Dent, Bubbles, White spot (Any Transparent Spot on Polarizer)	Minor	$\Phi \leq 0.5$ → Ignore if no Influence on Display $0.5 < \Phi$ $n = 0$ 
Fingerprint, Flow Mark (On Polarizer)	Minor	Not Allowable

* In displays which manifests itself has the other shadowing, ghosting or streaking.

** Distance between any 2 defects should over 10mm.

*** Definition of W & L & Φ (Unit: mm): $\Phi = (a + b) / 2$

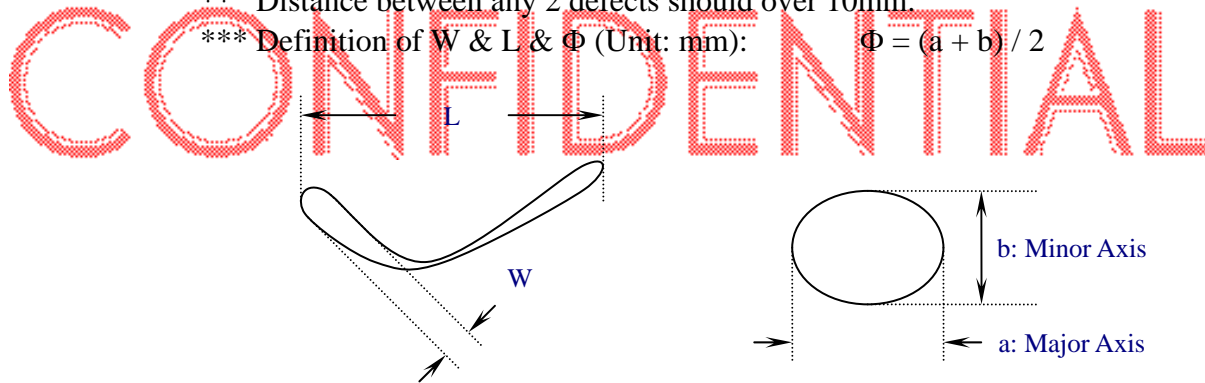

6.3.3 Pattern Check (Display On) in Active Area

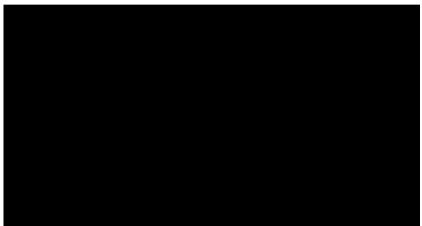
Check Item	Classification	Criteria
No Display	Major	
Flicker	Major	Not Allowable

6.3.3 Pattern Check (Display On) in Active Area (Continued)

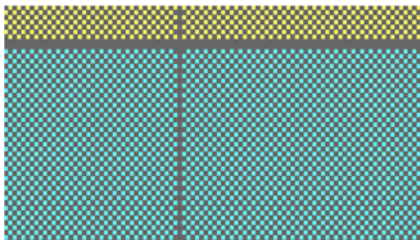
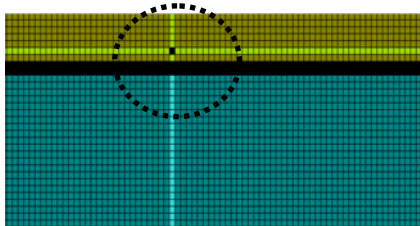
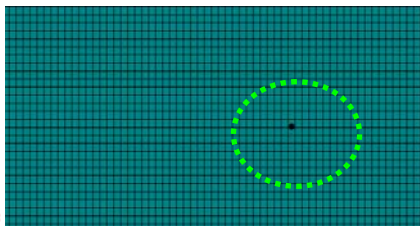
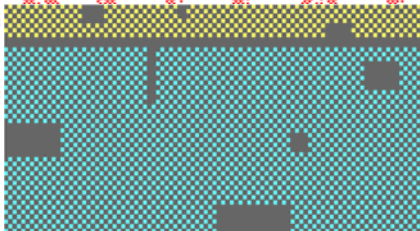
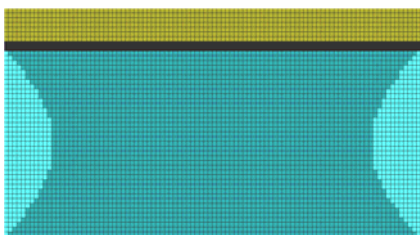
Check Item	Classification	Criteria
Missing Line	Major	
Pixel Short	Major	
Darker Pixel	Major	
Wrong Display	Major	
Un-uniform	Major	

CONFIDENTIAL

7. Package Specifications

7.1 Inner Carton Box

Each OEL display module will be placed on the antistatic tray and up to 600 units at the maximum will be packaged into the inner carton box. A label indicating the flowing contents will be applied to the surface of the inner carton box.

Univision Technology Inc.	
Product Number: UG-2864GMBAF01	
Quantity 600 pieces	Lot XXXXXXXXXX
Customer Product Number: XXXXXXXXXXXX	
QC Check :	Date: 2005.6.15

Contents of the label indication

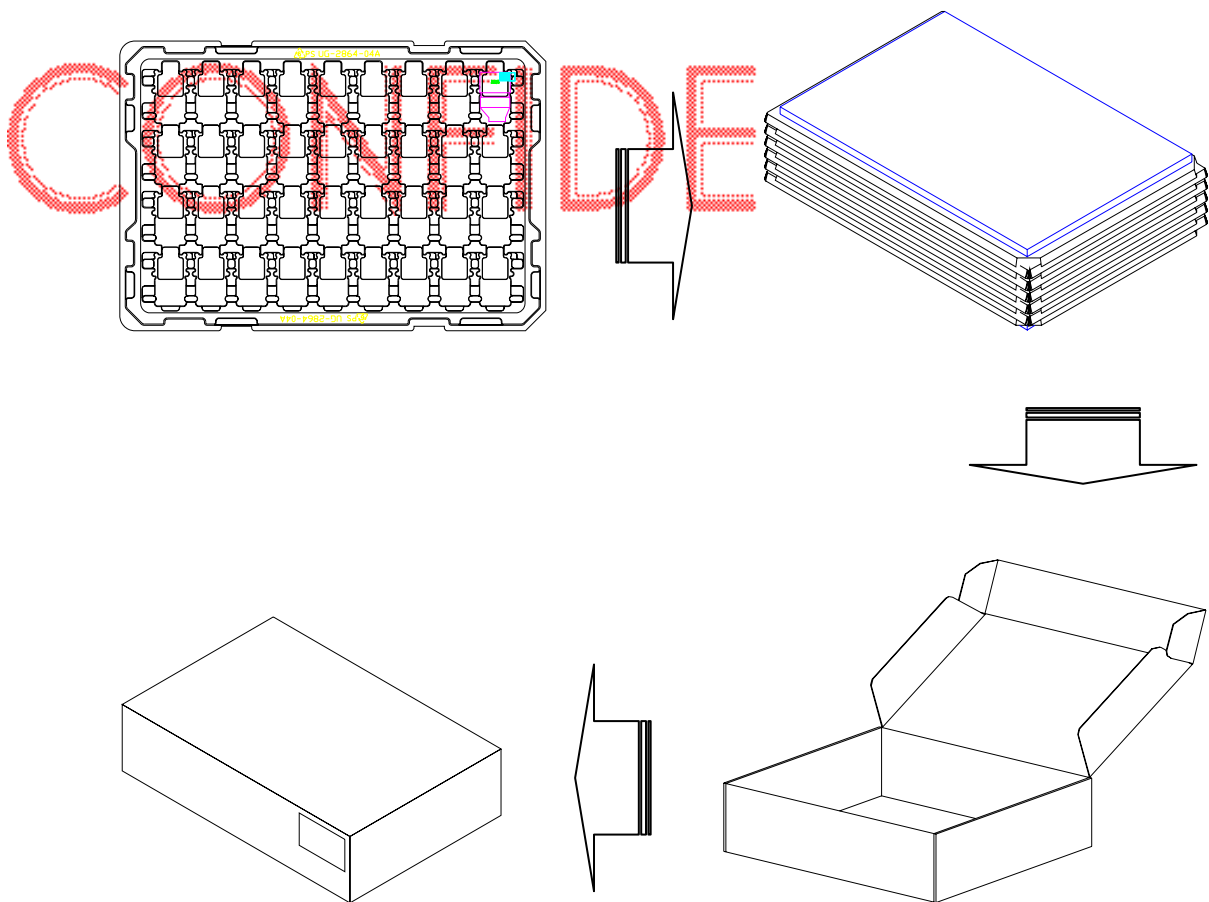

7.2 Master Carton Box

The Master Carton Box is the unit package to deliver to each customer. The Master Carton Box contains 4 inner carton boxes.

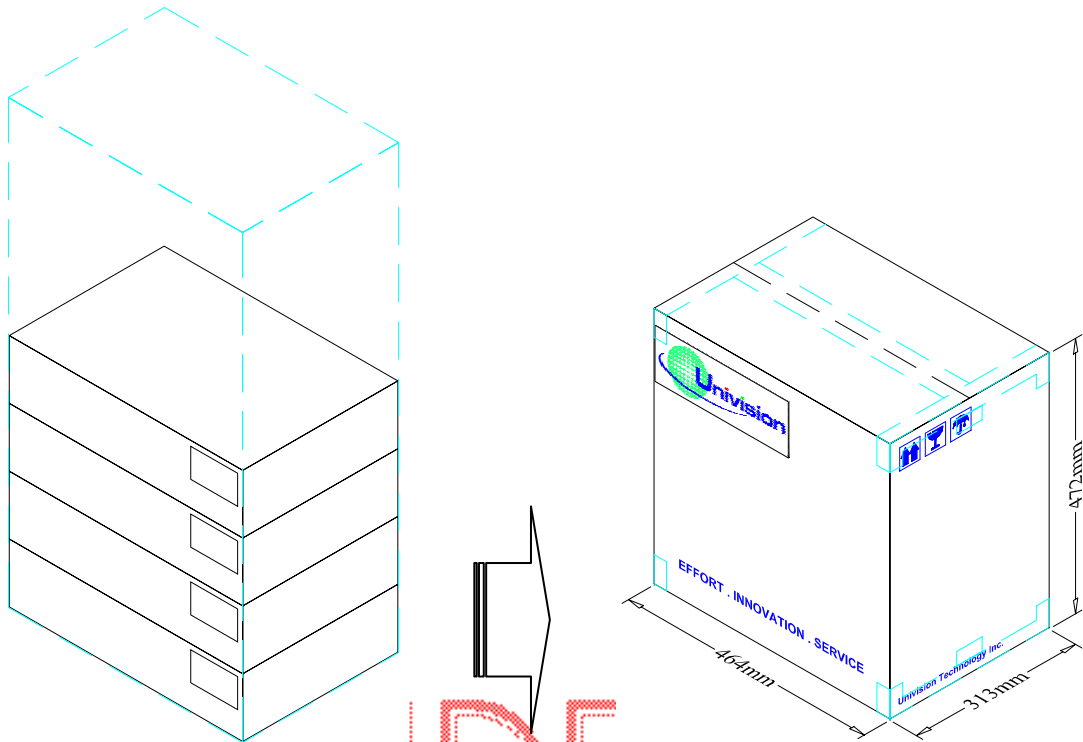

CONFIDENTIAL

8. Precautions When Using These OEL Display Modules

8.1 Handling Precautions

- 1) Since the display panel is being made of glass, do not apply mechanical impacts such as dropping from a high position.
- 2) If the display panel is broken by some accident and the internal organic substance leaks out, be careful not to inhale nor lick the organic substance.
- 3) If pressure is applied to the display surface or its neighborhood of the OEL display module, the cell structure may be damaged and be careful not to apply pressure to these sections.
- 4) The polarizer covering the surface of the OEL display module is soft and easily scratched. Please be careful when handling the OEL display module.
- 5) When the surface of the polarizer of the OEL display module has soil, clean the surface. It takes advantage of by using following adhesion tape.
 - * Scotch Mending Tape No. 810 or an equivalentNever try to breathe upon the soiled surface nor wipe the surface using cloth containing solvent such as ethyl alcohol, since the surface of the polarizer will become cloudy.
Also, pay attention that the following liquid and solvent may spoil the polarizer:
 - * Water
 - * Ketone
 - * Aromatic Solvents
- 6) When installing the OEL display module, be careful not to apply twisting stress or deflection stress to the OEL display module. And, do not over bend the film with electrode pattern layouts. These stresses will influence the display performance. Also, secure sufficient rigidity for the outer cases.
- 7) Do not apply stress to the LSI chips and the surrounding molded sections.
- 8) Do not disassemble nor modify the OEL display module.
- 9) Do not apply input signals while the logic power is off.
- 10) Pay sufficient attention to the working environments when handling OEL display modules to prevent occurrence of element breakage accidents by static electricity.
 - * Be sure to make human body grounding when handling OEL display modules.
 - * Be sure to ground tools to use or assembly such as soldering irons.
 - * To suppress generation of static electricity, avoid carrying out assembly work under dry environments.
 - * Protective film is being applied to the surface of the display panel of the OEL display module. Be careful since static electricity may be generated when exfoliating the protective film.
- 11) Protection film is being applied to the surface of the display panel and removes the protection film before assembling it. At this time, if the OEL display module has been stored for a long period of time, residue adhesive material of the protection film may remain on the surface of the display panel after removed of the film. In such case, remove the residue material by the method introduced in the above Section 5).
- 12) If electric current is applied when the OEL display module is being dewed or when it is placed under high humidity environments, the electrodes may be

corroded and be careful to avoid the above.

8.2 Storage Precautions

- 1) When storing OEL display modules, put them in static electricity preventive bags avoiding exposure to direct sun light nor to lights of fluorescent lamps, etc. and, also, avoiding high temperature and high humidity environments or low temperature (less than 0°C) environments. (We recommend you to store these modules in the packaged state when they were shipped from Univision Technology Inc.)

At that time, be careful not to let water drops adhere to the packages or bags nor let dewing occur with them.

- 2) If electric current is applied when water drops are adhering to the surface of the OEL display module, when the OEL display module is being dewed or when it is placed under high humidity environments, the electrodes may be corroded and be careful about the above.

8.3 Designing Precautions

- 1) The absolute maximum ratings are the ratings which cannot be exceeded for OEL display module, and if these values are exceeded, panel damage may be happen.
- 2) To prevent occurrence of malfunctioning by noise, pay attention to satisfy the VIL and VIH specifications and, at the same time, to make the signal line cable as short as possible.
- 3) We recommend you to install excess current preventive unit (fuses, etc.) to the power circuit (VDD). (Recommend value: 0.5A)
- 4) Pay sufficient attention to avoid occurrence of mutual noise interference with the neighboring devices.
- 5) As for EMI, take necessary measures on the equipment side basically.
- 6) When fastening the OEL display module, fasten the external plastic housing section.
- 7) If power supply to the OEL display module is forcibly shut down by such errors as taking out the main battery while the OEL display panel is in operation, we cannot guarantee the quality of this OEL display module.
- 8) The electric potential to be connected to the rear face of the IC chip should be as follows: SSD1303
* Connection (contact) to any other potential than the above may lead to rupture of the IC.

8.4 Precautions when disposing of the OEL display modules

- 1) Request the qualified companies to handle industrial wastes when disposing of the OEL display modules. Or, when burning them, be sure to observe the environmental and hygienic laws and regulations.

8.5 Other Precautions

- 1) When an OEL display module is operated for a long of time with fixed pattern

may remain as an after image or slight contrast deviation may occur.

Nonetheless, if the operation is interrupted and left unused for a while, normal state can be restored. Also, there will be no problem in the reliability of the module.

- 2) To protect OEL display modules from performance drops by static electricity rapture, etc., do not touch the following sections whenever possible while handling the OEL display modules.
 - * Pins and electrodes
 - * Pattern layouts such as the COF
- 3) With this OEL display module, the OEL driver is being exposed. Generally speaking, semiconductor elements change their characteristics when light is radiated according to the principle of the solar battery. Consequently, if this OEL driver is exposed to light, malfunctioning may occur.
 - * Design the product and installation method so that the OEL driver may be shielded from light in actual usage.
 - * Design the product and installation method so that the OEL driver may be shielded from light during the inspection processes.
- 4) Although this OEL display module stores the operation state data by the commands and the indication data, when excessive external noise, etc. enters into the module, the internal status may be changed. It therefore is necessary to take appropriate measures to suppress noise generation or to protect from influences of noise on the system design.
- 5) We recommend you to construct its software to make periodical refreshment of the operation statuses (re-setting of the commands and re-transference of the display data) to cope with catastrophic noise.

CONFIDENTIAL