

Version : 2.0



<p>TECHNICAL SPECIFICATION</p> <p>MODEL NO. : PD064VT2</p>
--

Customer's Confirmation

Customer \_\_\_\_\_

Date \_\_\_\_\_

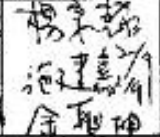
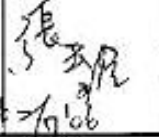
By \_\_\_\_\_

Dep	FAE	Panel Design	Electronic Design	Mechanical Design	Product Verification	Prepared by
SIGN						

**TECHNICAL SPECIFICATION****CONTENTS**

<b>NO.</b>	<b>ITEM</b>	<b>PAGE</b>
-	Cover	1
-	Contents	2
1	Application	3
2	Features	3
3	Mechanical Specifications	3
4	Mechanical Drawing of TFT-LCD module	4
5	Input / Output Terminals	6
6	Absolute Maximum Ratings	7
7	Electrical Characteristics	7
8	Power On Sequence	13
9	Optical Characteristics	14
10	Handling Cautions	17
11	Reliability Test	18
12	Block Diagram	19
13	Packing Diagram	20
-	Revision History	21

## 1. Application

This product applies computer peripheral, industrial meter, image communication, web-pad, e-boobs and multi-media.

## 2. Features

- . Pixel in stripe configuration
- . Slim and compact
- . Display Colors : 262,144 colors
- . Viewing Direction : 6 o'clock
- . Slim module design for mobile electronics device application

## 3. Mechanical Specifications

Parameter	Specifications	Unit
Screen Size	6.4(diagonal)	inch
Display Format	640x(R, G, B)x480	dot
Display Colors	262,144	
Active Area	129.6(H)x97.44(V)	mm
Pixel Pitch	0.2025(H)x0.203(V)	mm
Pixel Configuration	Stripe	
Outline Dimension	159 (W)x117 (H)x6.4 (typ.) (D)	mm
Weight	165±10	g
Back-light	CCFL, 1 tube	
Surface treatment	Anti-glare	
Display mode	Normally white	

**4. Mechanical Drawing of TFT-LCD Module**

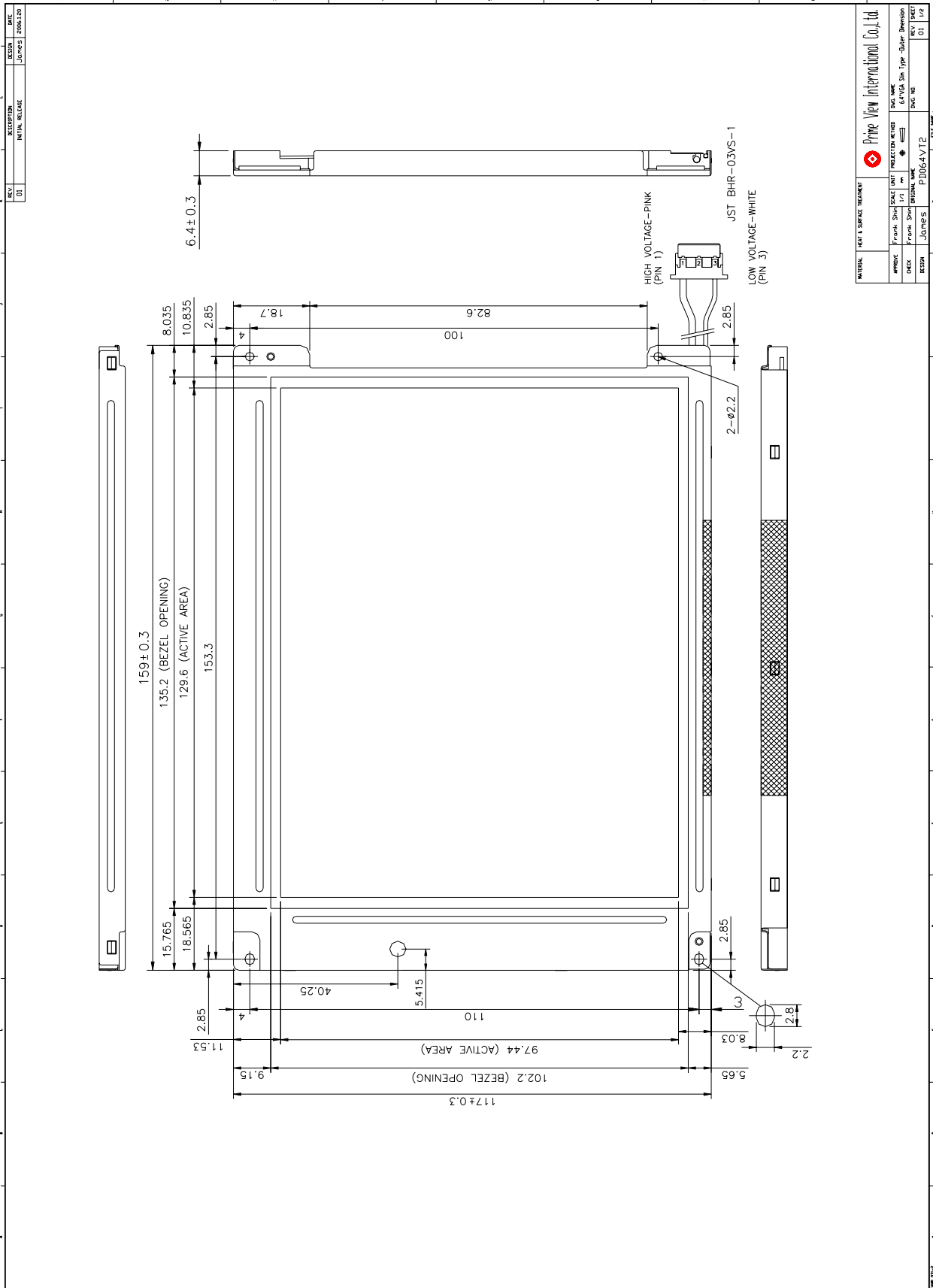

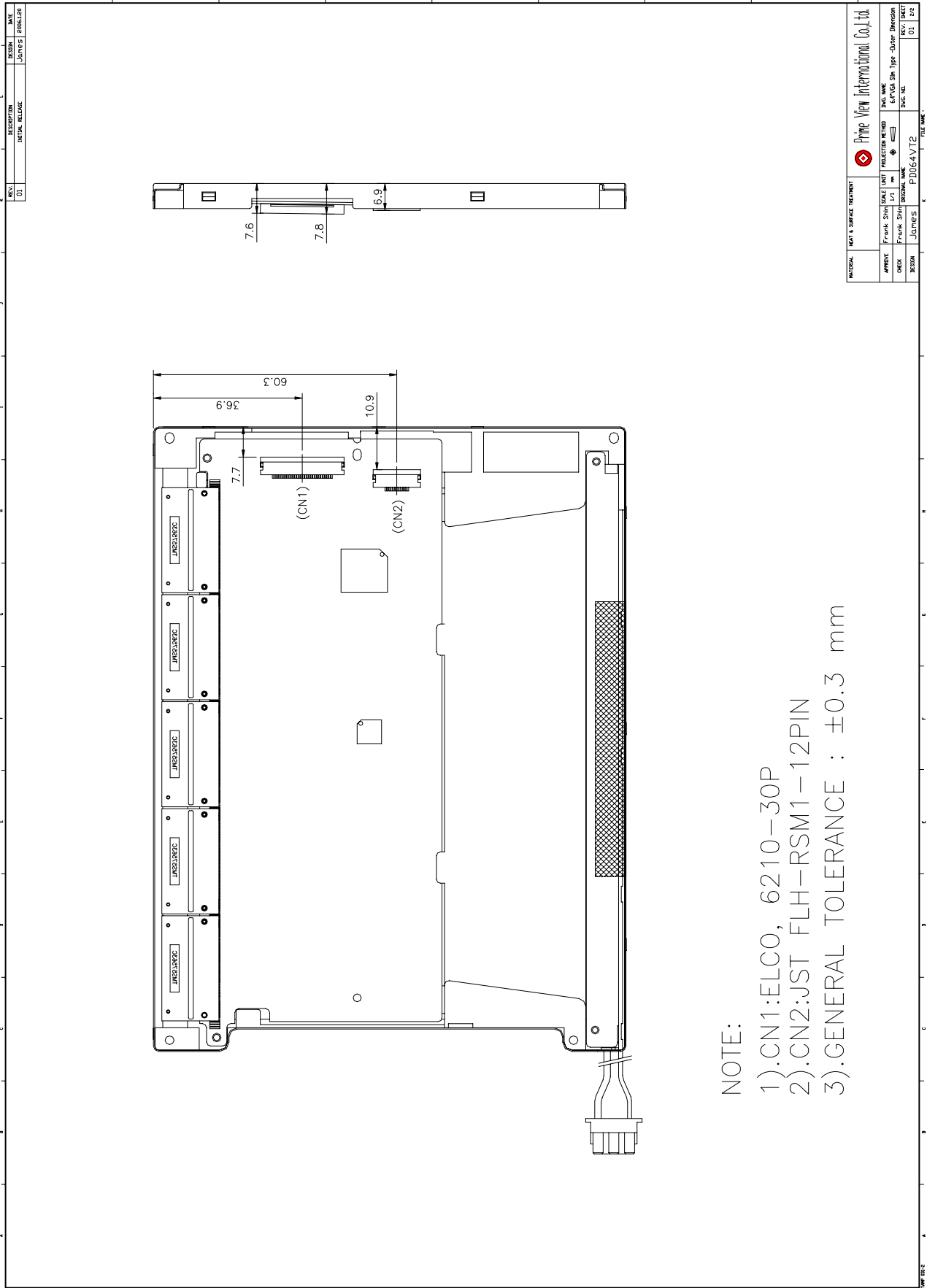

NOTE:  
 1).CN1:ELCO, 6210-30P  
 2).CN2:JST FLH-RSM1-12PIN  
 3).GENERAL TOLERANCE : ±0.3 mm

REV.	DESCRIPTION	DATE
01	INITIAL RELEASE	JONES

PRIME VIEW INTERNATIONAL CO., LTD.	
APPROVE	FRANK SHIH
CHECK	FRANK SHIH
DESIGN	JONES
FILE NAME	PD064VT2
REV. SHEET	01 / 02

5. Input / Output Terminals

5-1) TFT-LCD Panel Driving

Connector (1) type : ELCO , 6210-30PIN

Pin No.	Symbol	Function	Remark
1	CLK	Clock Signal for Sampling Image Digital Data	
2	Hsync	Horizontal Synchronous Signal	
3	Vsync	Vertical Synchronous Signal	
4	GND	Ground (0V)	
5	R0	Red Image Data Signal (LSB)	
6	R1	Red Image Data Signal	
7	R2	Red Image Data Signal	
8	R3	Red Image Data Signal	
9	R4	Red Image Data Signal	
10	R5	Red Image Data Signal (MSB)	
11	GND	Ground (0V)	
12	G0	Green Image Data Signal (LSB)	
13	G1	Green Image Data Signal	
14	G2	Green Image Data Signal	
15	G3	Green Image Data Signal	
16	G4	Green Image Data Signal	
17	G5	Green Image Data Signal (MSB)	
18	GND	Ground (0V)	
19	B0	Blue Image Data Signal (LSB)	
20	B1	Blue Image Data Signal	
21	B2	Blue Image Data Signal	
22	B3	Blue Image Data Signal	
23	B4	Blue Image Data Signal	
24	B5	Blue Image Data Signal (MSB)	
25	GND	Ground (0V)	
26	NC	No connection	
27	VCC	DC +3.3V Power Supply	Note 5-1
28	VCC	DC +3.3V Power Supply	Note 5-1
29	NC	No connection	
30	NC	No connection	

Note 5-1 :Vcc (typ)=+3.3V

5-2) Backlight driving

Pin No	Symbol	Description	Remark
1	VL1	Input terminal (Hi voltage side)	Wire color : Pink
2	NC	No Connection	
3	VL2	Input terminal (Low voltage side)	Wire Color : White Note 5-2

Note 5-2 : Low voltage side of backlight inverter connects with ground of inverter circuits.

5-3) Input / Output Connector

- A) LCD module connector  
ELCO , 6210-30PIN  
Down Connector  
Pin No. : 30 pins  
Pitch : 0.5 mm
  
- B) Backlight Connector  
JST BHR-03VS-1  
Pin No. : 3 pins  
Pitch : 4 mm  
Red : High Voltage  
White : Low Voltage

6. Absolute Maximum Ratings :

GND=0V, Ta=25

Parameters	Symbol	MIN.	MAX.	Unit	Remark
Supply Voltage	V <sub>CC</sub>	-0.3	+4.0	V	V <sub>CC</sub> =+3.3V
Input Signals Voltage	V <sub>sig</sub>	-0.3	V <sub>CC</sub> +0.3	V	Note 6-1

Note 6-1 : Input signals include CLK, Hsync, Vsync, R[0:5], G[0:5] and B[0:5].

7. Electrical Characteristics

7-1) Recommended Operating Conditions :

- A) Driving for TFT-LCD panel

GND = 0V , Ta = 25

Parameters	Symbol	Min.	Typ.	Max.	Unit	Remark
Supply Voltage	V <sub>CC</sub>	+3.15	+3.3	+3.6	V	
Supply Input Ripple Voltage	V <sub>CCRP</sub>			0.1	V <sub>p-p</sub>	V <sub>CC</sub> =+3.3V
Input Signals Voltage (High)	V <sub>IH</sub>	+3.0	+3.3	+3.6	V	
Input Signals Voltage (Low)	V <sub>IL</sub>	-	0	+0.3	V	

- B) Driving for backlight

Ta = 25

Item	Symbol	Min.	Typ.	Max.	Unit	Remark
Lamp Current	I <sub>L</sub>	3	5	7	mA	Note 7-1
Lamp Voltage	V <sub>L</sub>	350	390	420	V <sub>rms</sub>	
Oscillation	P <sub>L</sub>	45	64	80	KHz	Note 7-2
Lamp Life Time	-	-	20,000	-	Hr	
Kick-off voltage(25 ) (Reference Value)	V <sub>s</sub>	-	845	1,050	V <sub>rms</sub>	Note 7-3
Kick-off voltage(0 ) (Reference Value)	V <sub>s</sub>	-	1,045	1,250	V <sub>rms</sub>	Note 7-3

Note 7-1 : In order to satisfy the quality of B/L , no matter use what kind of inverter , the output lamp current must between Min. and Max. to avoid the abnormal display image caused by B/L.

Note 7-2 : The waveform of lamp driving voltage should be as closed to a perfect sine wave as possible.

Note 7-3: The " Max of starting voltage " means the minimum voltage of inverter to turn on the CCFL. and it should be applied to the lamp for more than 1 second to start up. Otherwise the lamp may not be turned on.

PVI strongly recommend that the minimum voltage of inverter could be designed for 0°C condition.

### 7-2) Power Consumption

Parameters	Symbol	Typ.	Max.	Unit	Remark
+3.3V Current Dissipation	$I_{CC}$	170	200	mA	
Input Signals Current (High)	$I_{IH}$	-	100	$\mu A$	$V_{IH} = +3.3V$
Input Signals Current (Low)	$I_{IL}$	-	100	$\mu A$	$V_{IL} = 0V$
LCD Panel Power Consumption(W/O B/L)	-	0.56	0.66	W	
Backlight Power Consumption	-	1.95	2.10	W	Note 7-4

Note 7-4: Backlight lamp power consumption is calculated by  $I_L \times V_L$ .

### 7-3) Input / Output signal timing chart

Parameters	Symbol	Min.	Typ.	Max.	Unit	Note	
Frequency	$F_c = 1/t_c$		25.175		MHz	Note 7-6	
Clock	High Time	Tckh	10		ns		
	Low Time	Tckl	10		ns		
	Periodic = Line	Thp		31.778	$\mu s$	Note 7-6	
Hsync			800	1024	clock	Note 7-6	
	Pulse Width	Thpw	2	96	200	clock	
	Back Porch	Thbp	2	49	64	clock	
			515	525	1024	line	Note 7-6
Vsync	Pulse Width	Tvpw	1	2		line	
	Back Porch	Tvbp	1	33	64	line	
Data	Setup Time	Tds	10			ns	
	Hold Time	Tdh	10			ns	
	Periodic = Line	Tep		800	1024	clock	
	Pulse Width (H)	Tepw	2	640	800	clock	
Horizontal Display Periodic	Thd	640	640	640	clock		
Hsync-CLK Phase Difference	Thc	10		Tc-10	ns		
Vsync-Hsync Phase Difference	Tvh	1		Thp-1	clock		

Note 7-6 :  $t_c$  is the period of sampling clock. In case of low-frequency, the image-flicker may occur.

7-4) Display Time Range

(1) Vertical Timing :

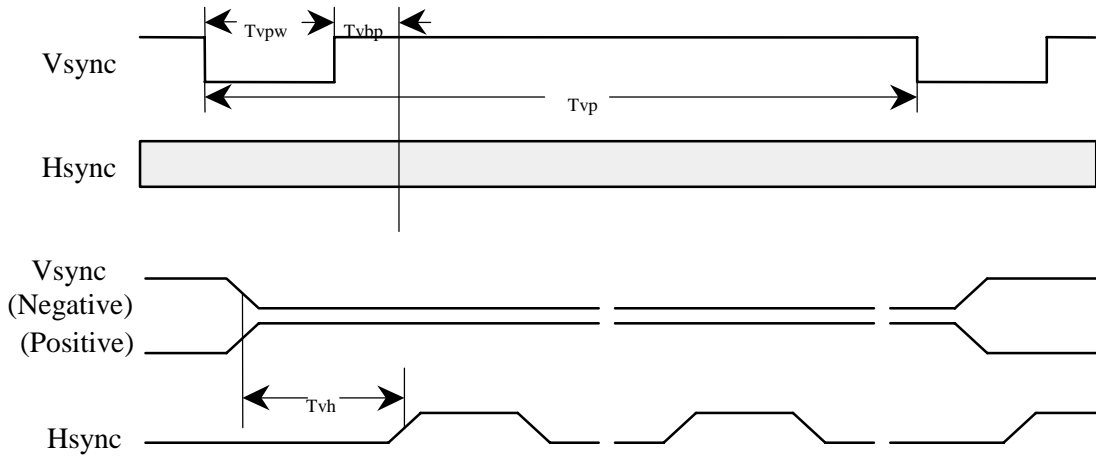

(2) Horizontal Timing :

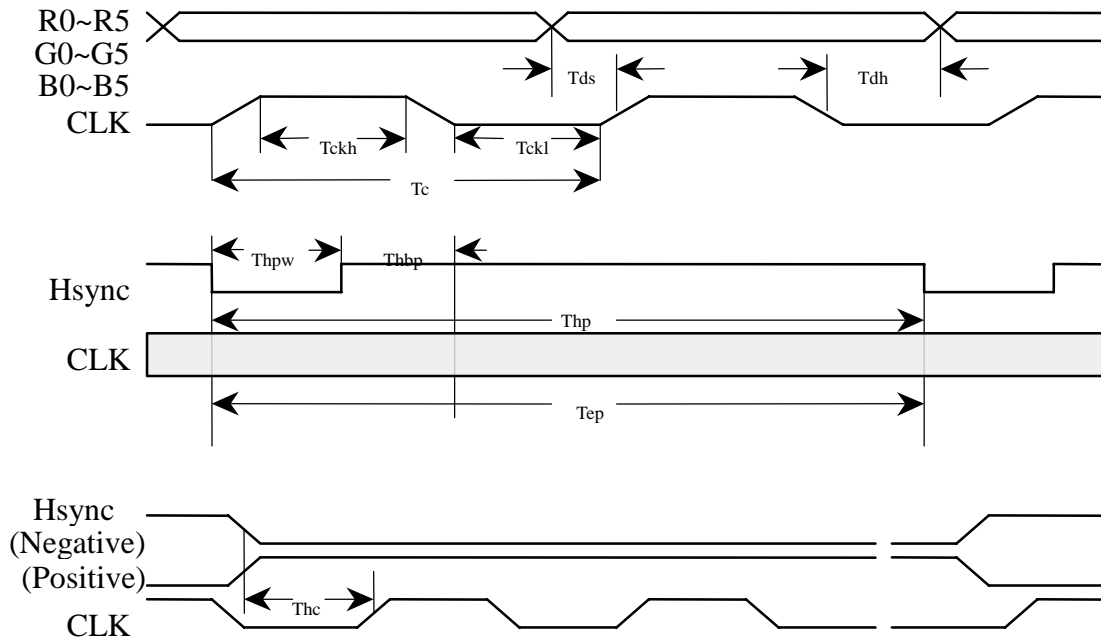

(3). Detail of Horizontal Timing :

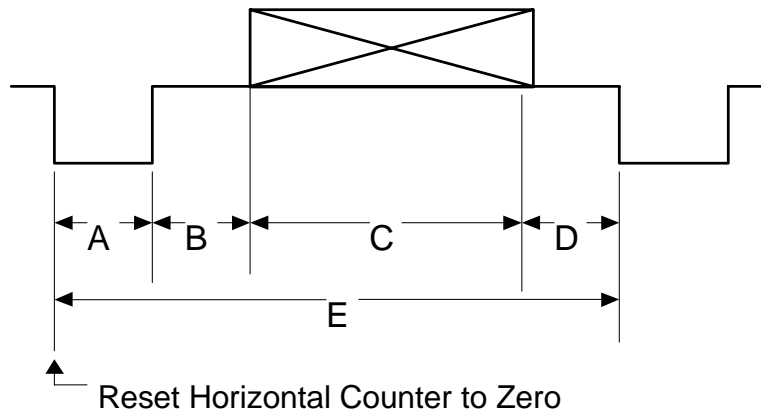

Item	Description	Clock Cycles	Time
A	Horizontal Width	96	3.813 $\mu$ s
B	Horizontal B-Porch	49	1.907 $\mu$ s
C	Horizontal Display	640	25.422 $\mu$ s
D	Horizontal F-Porch	16	0.636 $\mu$ s
E	Horizontal Total	800	31.778 $\mu$ s

(4). Detail of Vertical Timing :

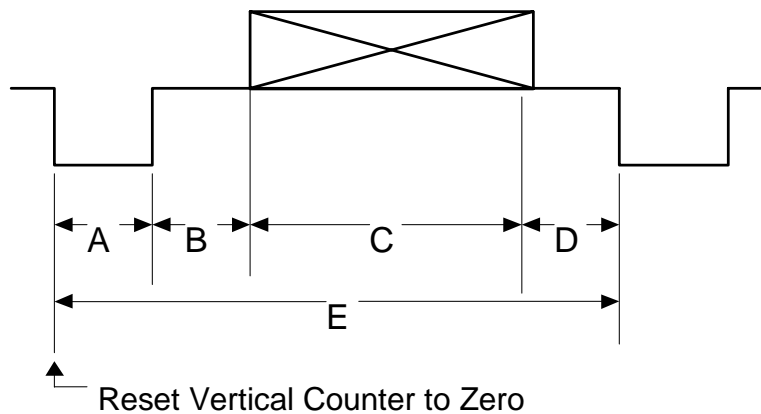

Item	Description	Horizontal Lines	Time
A	Vertical Width	2	63.5 $\mu$ s
B	Vertical B-Porch	33	1.049 ms
C	Vertical Display	480	15.253 ms
D	Vertical F-Porch	10	317.8 $\mu$ s
E	Vertical Total	525	16.683 ms

7-5) Pixel Arrangement

The LCD module pixel arrangement is the stripe.

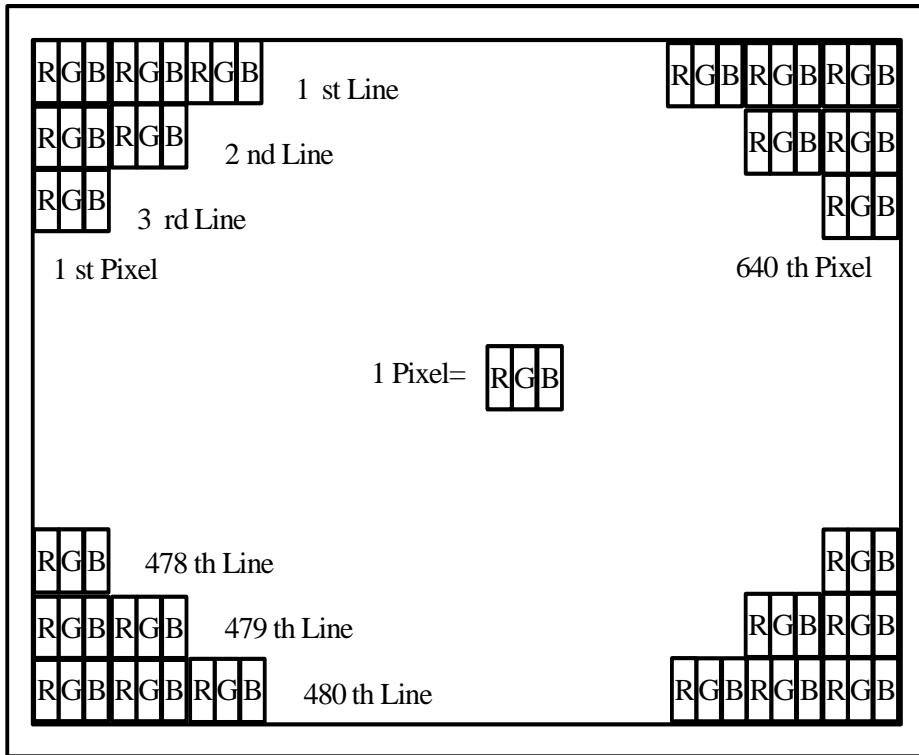

7-6) Display Color and Gray Scale Reference

Color		Input Color Data																	
		Red						Green						Blue					
		R5	R4	R3	R2	R1	R0	G5	G4	G3	G2	G1	G0	B5	B4	B3	B2	B1	B0
Basic Colors	Black	0	0	0	0	0	0	0	0	0	0	0	0	0	0	0	0	0	0
	Red (63)	1	1	1	1	1	1	0	0	0	0	0	0	0	0	0	0	0	0
	Green (63)	0	0	0	0	0	0	1	1	1	1	1	1	0	0	0	0	0	0
	Blue (63)	0	0	0	0	0	0	0	0	0	0	0	0	1	1	1	1	1	1
	Cyan	0	0	0	0	0	0	1	1	1	1	1	1	1	1	1	1	1	1
	Magenta	1	1	1	1	1	1	0	0	0	0	0	0	1	1	1	1	1	1
	Yellow	1	1	1	1	1	1	1	1	1	1	1	1	0	0	0	0	0	0
	White	1	1	1	1	1	1	1	1	1	1	1	1	1	1	1	1	1	1
Red	Red (00)	0	0	0	0	0	0	0	0	0	0	0	0	0	0	0	0	0	0
	Red (01)	0	0	0	0	0	1	0	0	0	0	0	0	0	0	0	0	0	0
	Red (02)	0	0	0	0	1	0	0	0	0	0	0	0	0	0	0	0	0	0
	Darker																		
	Brighter																		
	Red (61)	1	1	1	1	0	1	0	0	0	0	0	0	0	0	0	0	0	0
	Red (62)	1	1	1	1	1	0	0	0	0	0	0	0	0	0	0	0	0	0
	Red (63)	1	1	1	1	1	1	0	0	0	0	0	0	0	0	0	0	0	0
Green	Green (00)	0	0	0	0	0	0	0	0	0	0	0	0	0	0	0	0	0	0
	Green (01)	0	0	0	0	0	0	0	0	0	0	0	1	0	0	0	0	0	0
	Green (02)	0	0	0	0	0	0	0	0	0	0	1	0	0	0	0	0	0	0
	Darker																		
	Brighter																		
	Green (61)	0	0	0	0	0	0	1	1	1	1	0	1	0	0	0	0	0	0
	Green (62)	0	0	0	0	0	0	1	1	1	1	1	0	0	0	0	0	0	0
	Green (63)	0	0	0	0	0	0	1	1	1	1	1	1	0	0	0	0	0	0
Blue	Blue (00)	0	0	0	0	0	0	0	0	0	0	0	0	0	0	0	0	0	0
	Blue (01)	0	0	0	0	0	0	0	0	0	0	0	0	0	0	0	0	0	1
	Blue (02)	0	0	0	0	0	0	0	0	0	0	0	0	0	0	0	0	1	0
	Darker																		
	Brighter																		
	Blue (61)	0	0	0	0	0	0	0	0	0	0	0	0	1	1	1	1	0	1
	Blue (62)	0	0	0	0	0	0	0	0	0	0	0	0	1	1	1	1	1	0
	Blue (63)	0	0	0	0	0	0	0	0	0	0	0	0	1	1	1	1	1	1

8. Power On Sequence

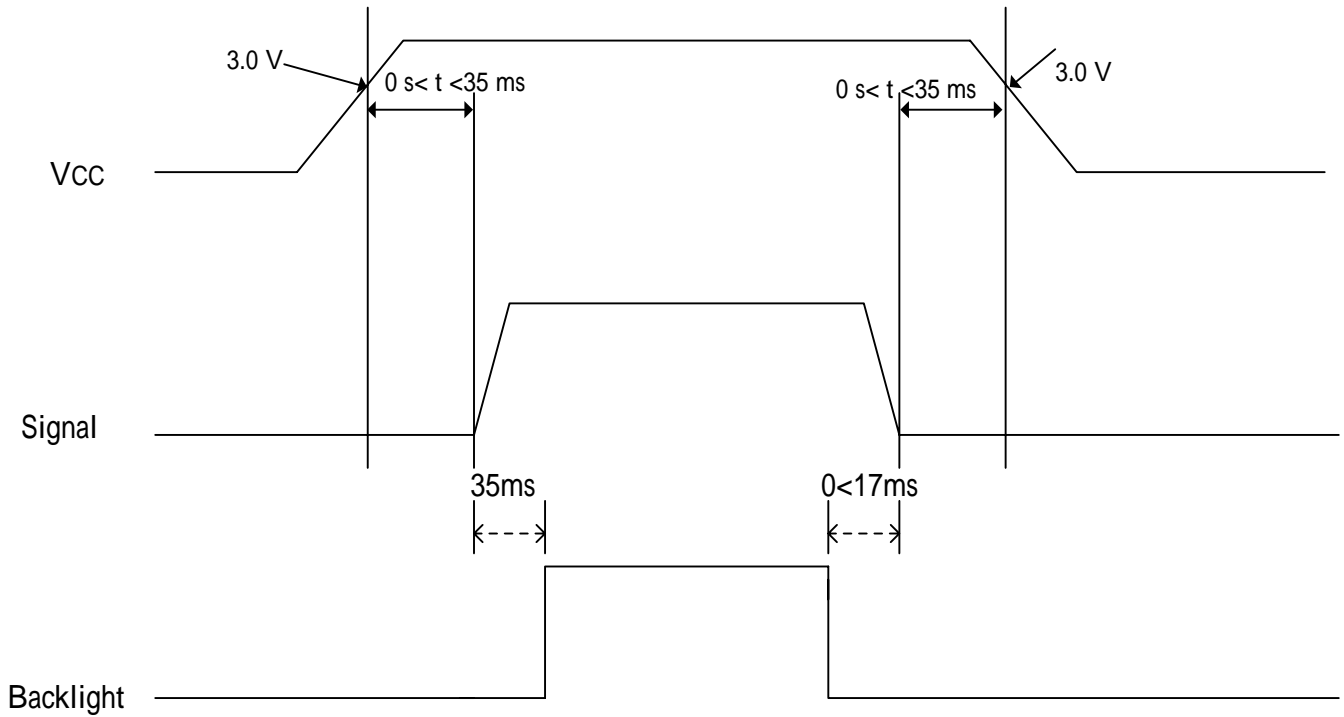

1. The supply voltage for input signals should be same as  $V_{CC}$ .
2. When the power is off , please keep whole signals (Hsync, Vsync, CLK, Data) low level or high impedance

9. Optical Characteristics

9-1) Specification :

Ta=25

Parameter	Symbol	Condition	MIN.	TYP.	MAX.	Unit	Remarks	
Viewing Angle	Horizontal	CR > 10	±35	±45		deg	Note 9-1	
	Vertical		(to 12 o'clock)	10	15	-		deg
			(to 6 o'clock)	30	35	-		deg
Contrast Ratio	CR		200	400	-	-	Note 9-2	
Response time	Rise	=0°	-	15	30	ms	Note 9-3	
	Fall		Tf	-	25	50		ms
Brightness		=0°/ =0	120	150		cd/m <sup>2</sup>	Note 9-4	
Luminance Uniformity	U		55	80	-	%	Note 9-5	
Lamp Life Time			-	20,000	-	hr		
White Chromaticity	x		0.230	0.280	0.330	-		
	y		0.270	0.320	0.370	-		
Cross Talk		=0°	-	-	3	%	Note 9-6	

All the optical measurement shall be executed 30 minutes after backlight being turn-on. The optical characteristics shall be measured in dark room (ambient illumination on panel surface less than 1 Lux). The measuring configuration shows as following figure.

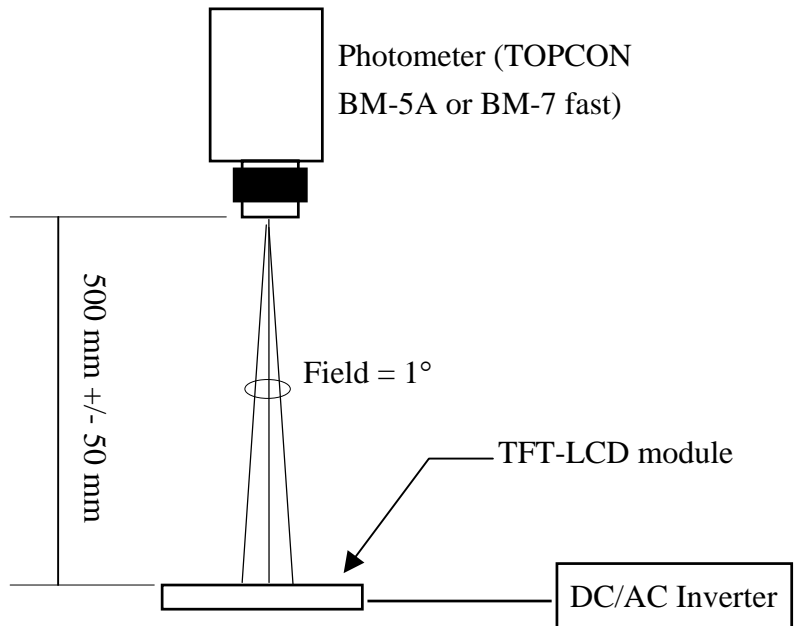

Optical characteristics measuring configuration

Note 9-1 : The definitions of viewing angle diagrams :

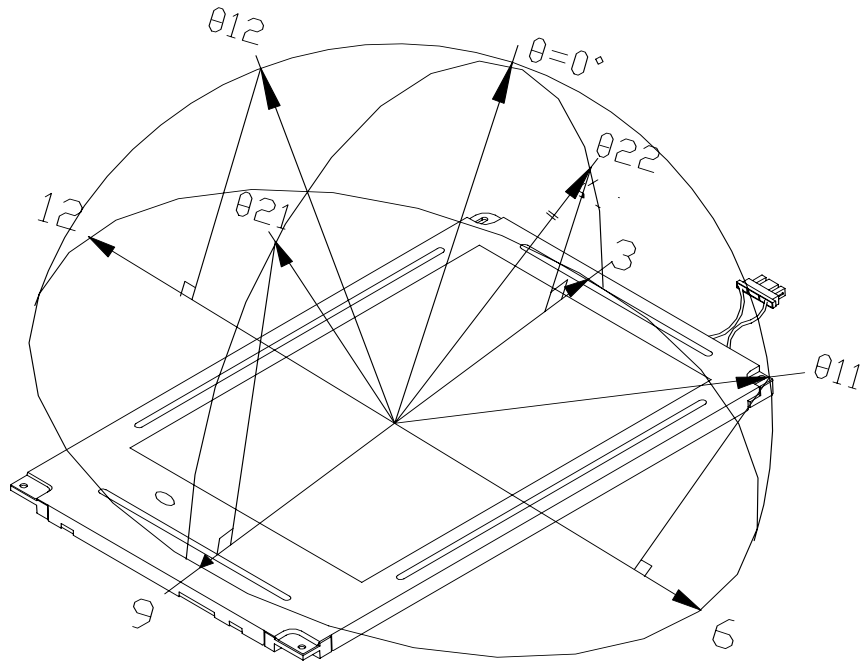

Note 9-2 :  $CR = \frac{\text{Luminance when LCD is White}}{\text{Luminance when LCD is Black}}$

Contrast Ratio is measured in optimum common electrode voltage.

Note 9-3 : Definition of Response Time  $T_r$  and  $T_f$ :

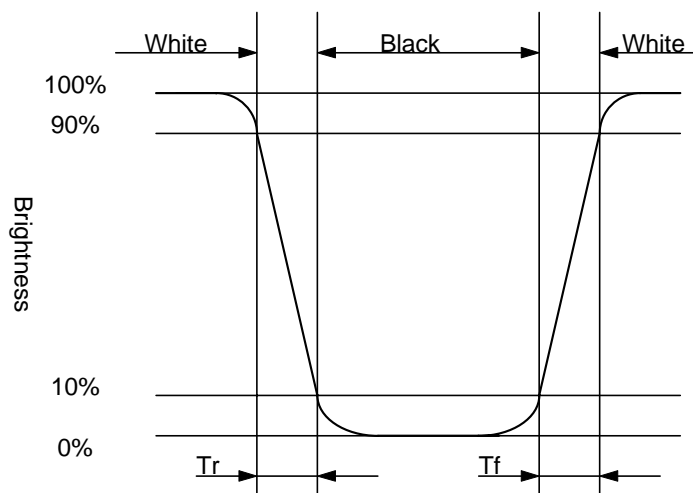

Note 9-4 : Topcon BM-7(fast) luminance meter 1°field of view is used in the testing (after 20~30 minutes' operation).

Note 9-5 : The uniformity of LCD is defined as

$$U = \frac{\text{The Minimum Brightness of the 9 testing Points}}{\text{The Maximum Brightness of the 9 testing Points}}$$

Luminance meter : BM-5A or BM-7 fast(TOPCON)  
 Measurement distance : 500 mm +/- 50 mm  
 Ambient illumination : < 1 Lux  
 Measuring direction : Perpendicular to the surface of module

The test pattern is white (Gray Level 63).

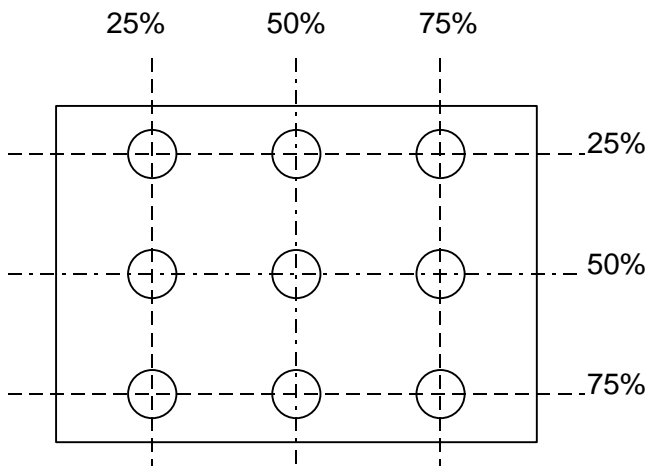

Note 9-6 : Cross Talk (CTK) =  $\frac{|YA-YB|}{YA} \times 100\%$

YA : Brightness of Pattern A

YB : Brightness of Pattern B

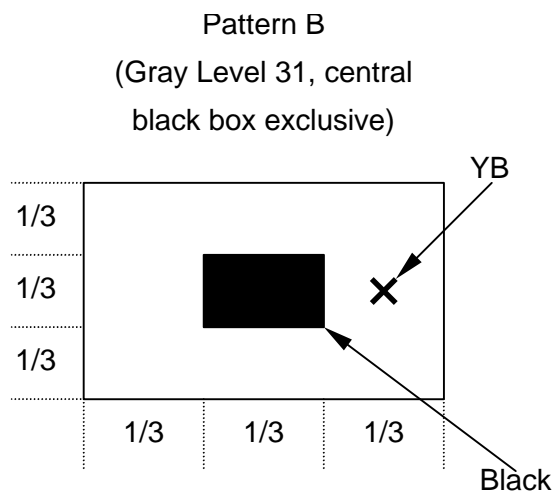
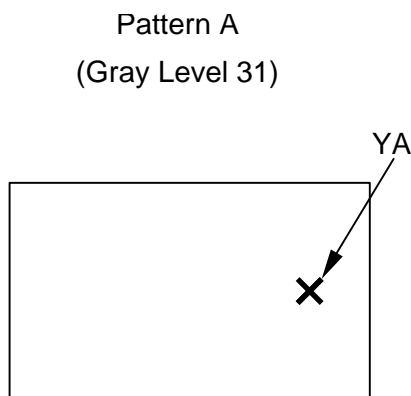

**X**: Testing Point (A and B are at the same point.)

Black (Gray Level 0)

---

## 10. Handling Cautions

### 10-1) Mounting of module

- a) Please power off the module when you connect the input/output connector.
- b) Please connect the ground pattern of the inverter circuit surely. If the connection is not perfect, some following problems may happen possibly.
  1. The noise from the backlight unit will increase.
  2. The output from inverter circuit will be unstable.
  3. In some cases a part of module will heat.
- c) Polarizer which is made of soft material and susceptible to flaw must be handled carefully.
- d) Protective film (Laminator) is applied on surface to protect it against scratches and dirt. It is recommended to peel off the laminator before use and taking care of static electricity.

### 10-2) Precautions in mounting

- a) When metal part of the TFT-LCD module (shielding lid and rear case) is soiled, wipe it with soft dry cloth.
- b) Wipe off water drops or finger grease immediately. Long contact with water may cause discoloration or spots.
- c) TFT-LCD module uses glass which breaks or cracks easily if dropped or bumped on hard surface. Please handle with care.
- d) Since CMOS LSI is used in the module. So take care of static electricity and earth yourself when handling.

### 10-3) Adjusting module

- a) Adjusting volumes on the rear face of the module have been set optimally before shipment.
- b) Therefore, do not change any adjusted values. If adjusted values are changed, the specifications described may not be satisfied.

### 10-4) Others

- a) Do not expose the module to direct sunlight or intensive ultraviolet rays for many hours.
- b) Store the module at a room temperature place.
- c) The voltage of beginning electric discharge may over the normal voltage because of leakage current from approach conductor by to draw lump read lead line around.
- d) If LCD panel breaks, it is possibly that the liquid crystal escapes from the panel. Avoid putting it into eyes or mouth. When liquid crystal sticks on hands, clothes or feet. Wash it out immediately with soap.
- e) Observe all other precautionary requirements in handling general electronic components.
- f) Please adjust the voltage of common electrode as material of attachment by 1 module.
- g) The UL number for PCB is EE2956.

**11. Reliability Test**

No	Test Item	Test Condition
1	High Temperature Storage Test	Ta = +70 , 240 hrs
2	Low Temperature Storage Test	Ta = -20 , 240 hrs
3	High Temperature Operation Test	Ta = +60 , 240 hrs
4	Low Temperature Operation Test	Ta = 0 , 240 hrs
5	High Temperature & High Humidity Operation Test	Ta = +40 , 95%RH, 240 hrs
6	Thermal Cycling Test (non-operating))	-20 +70 , 200 Cycles 30 min 30min
7	Vibration Test (non-operating)	Frequency : 10 ~ 57 H <sub>z</sub> /Vibration Width :0.075mm 58-500 H <sub>z</sub> / Gravity :9.8m/s <sup>2</sup> Sweep time: 11 minutes Test period: 3 hrs for each direction of X, Y, Z
8	Shock Test (non-operating)	Gravity :490m/s <sup>2</sup> Direction: ±X, ±Y, ±Z Pulse Width :11ms, half sine wave
9	Electrostatic Discharge Test (non-operating)	150pF , 330 Air : ±15KV ; Contact : ±8KV 10 times/point , 9 point/panel face

Ta: ambient temperature

Note : The protective film must be removed before temperature test.

[Criteria]

1. Main LCD should normally work under the normally condition no defect of function, screen quality and appearance (including : mura ,line defect ,no image)
2. After the temperature and humidity test, the luminance and CR (Contrast ratio) ,should not be lower than minimum of specification (section~10)
3. After the vibration and shock test , can't be find ,chip ,broken

12. Block Diagram

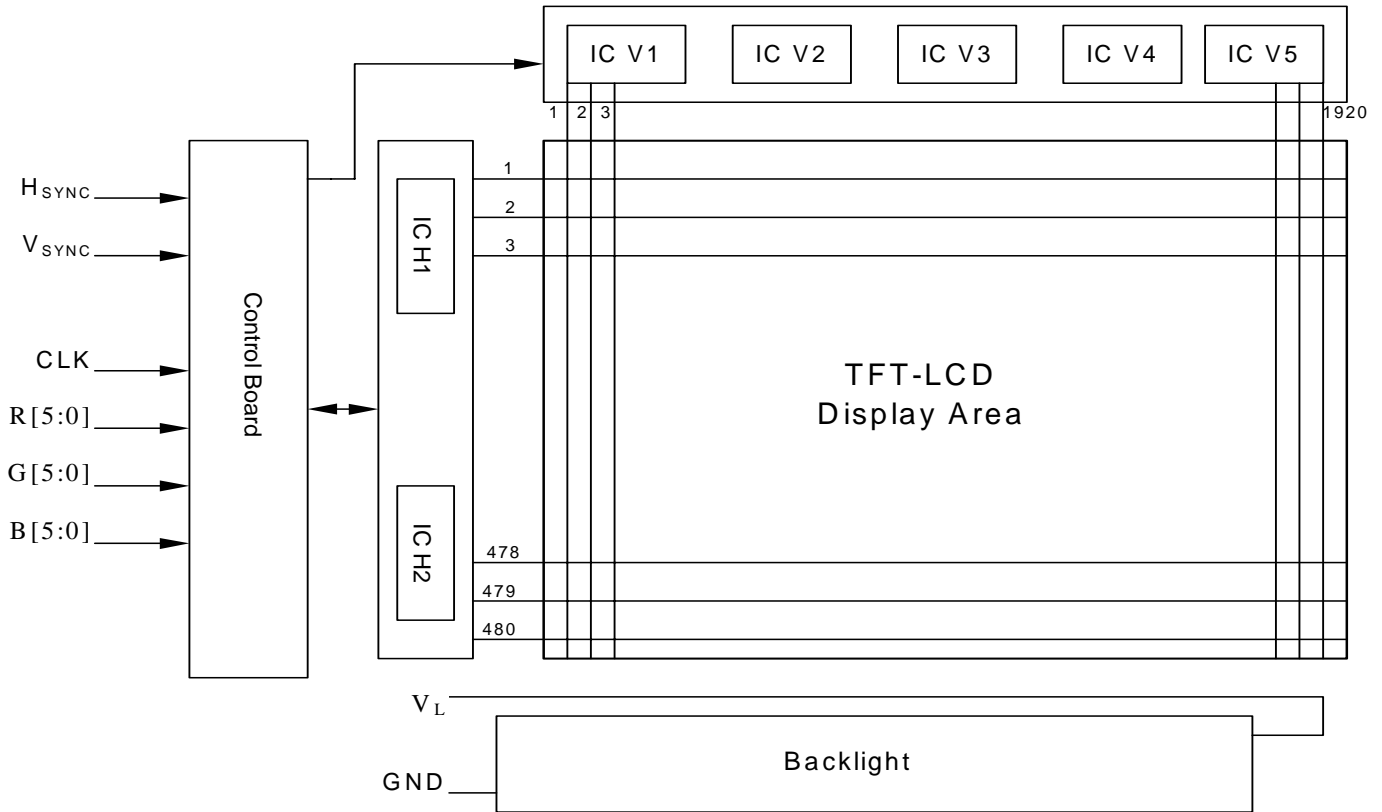

13. Packing

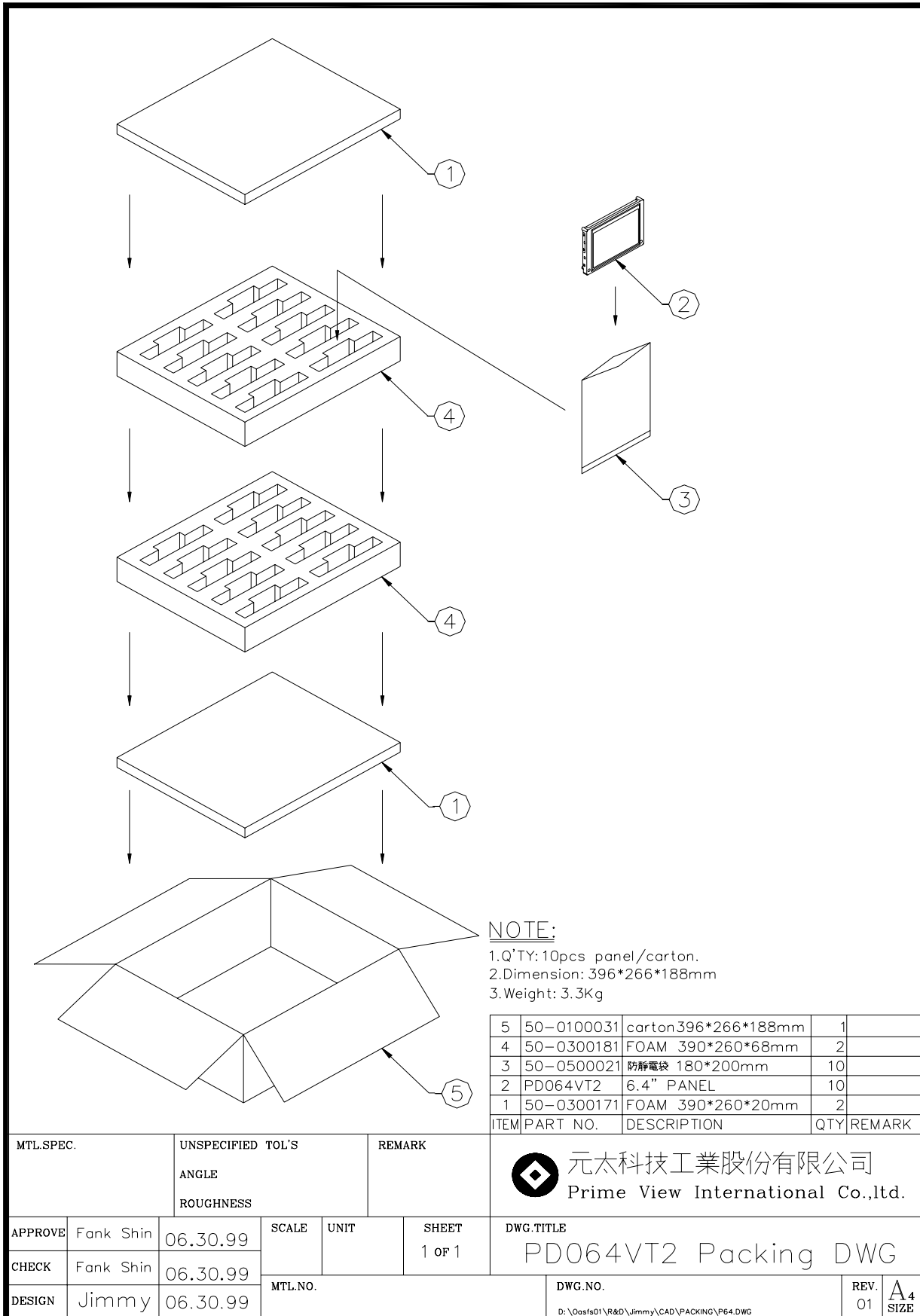

## Revision History

Rev.	Issued Date	Revised Contents
Preliminary (0.1)	Aug. 29, 2000	NEW
Preliminary (0.2)	Sept,21, 2000	Revise
Preliminary (0.3)	Jan.,17, 2001	Modify 1. Input signals and voltage=3.3V (typ.) 2. Page7 : Thbp=49 clock, Tvbp=33 line
Preliminary (0.4)	Feb.,20, 2001	Modify 1. Page6 : Oscillation=64KHZ ADD 1. Page6 : Kick-off voltage
Preliminary (0.5)	June, 04, 2001	Modify 1. 5-1) input pin define pin26 modify from "DENB" to "NC" 2. 7-1) Recommended operation condition Min. Input voltage modify from 3.0V to 3.15V 3. Erase original (7-6) Horizontal Display position, this section describes the "DENB" definition, which is useless in this module.
Preliminary (0.6)	July 20, 2001	Modify Page4: 4.Mechanical Drawing of TFT-LCD Module Page5: Connector(1) type : ELCO , 6210-30PIN
1.0	Aug 09,2001	Add Page12: Power On Sequence
1.1	Aug 15,2001	Modify 1. Page4:4.Mechanical Drawing of TFT-LCD Module 2. Page6:+3.3V Max. Supply Voltage from 7.0V to 4.0V.
1.2	Oct 17,2001	Add 1. Page14: Luminance Uniformity 2. Page14: Brightness measurement method 3. Pade15: Note 9-4: Definition of Response Time Tr and Tf
1.3	Dec 11,2001	Add Page17: Handling Cautions Page18: Indication of Lot Number Label
1.4	Apr. 10, 2002	Modify Page 7 : Driving for backlight Page 8 : Power Consumption
1.5	Apr. 12, 2002	Modify Page 14 : Optical Characteristics (Brightness)
1.6	Oct. 17, 2002	Modify Page 17 : Handling Cautions (The UL number)
1.7	Oct. 04, 2003	Modify Page 14 : Optical Characteristics (contrast ratio from 100 to 200 M (contrast ratio from 180 to 400 Typ.) Page 18 : Indication of Lot Number Label (The description of label)
1.8	Nov. 11,2004	Modify Page 8 : Note 7-1,7-2,7-3 Add Page 18 : Note 11-1 The protective film must be removed before temperature test.

1.9	Jan. 12,2005	Modify Page 18 : 11. Reliability Test→ Thermal Cycling Test condition From -25 +70 to -20 +70 Del Page 18 : 12. Indication of Lot Number Label
2.0	Feb 07,2006	Modify Page20.Packing Drawing